

# Directions for vaginal swab collection (for patients)

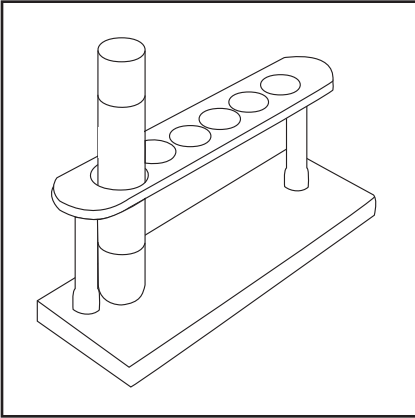

**Figure 1**

**1**

Open the vaginal swab collection kit.

**2**

Remove tube from package and place in test tube rack as shown in **Figure 1**. If there is no test tube rack, please check with clinic staff.

Remove cap from test tube without touching the inside of the cap or tube. If cap is dropped please notify clinic staff.

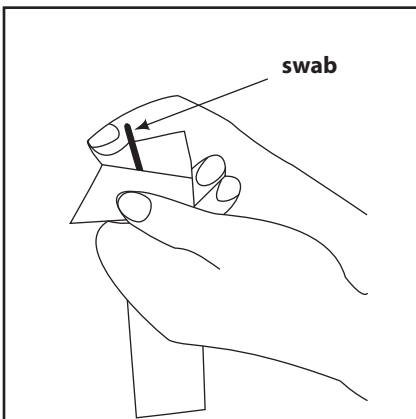

**Figure 2**

**3**

Remove swab package from collection kit.

**4**

Open the swab package as shown in **Figure 2**.

**5**

Remove the swab; do not touch the soft tip or lay the swab down.

**6**

Hold the swab as shown in **Figure 3**.

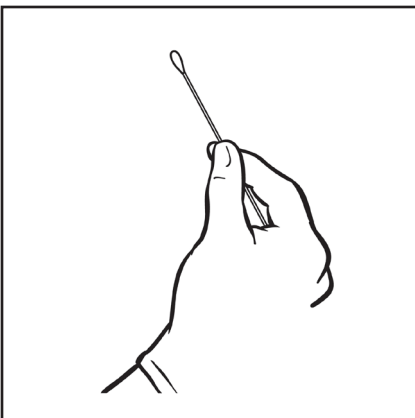

**Figure 3**

*Please turn page over*

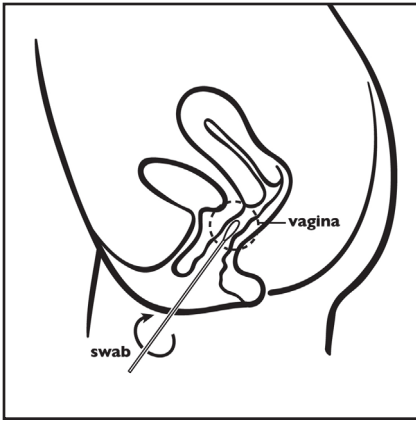

**Figure 4**

**7**

Insert the swab into your vagina about two inches as shown in **Figure 4**.

**8**

Gently rotate the swab for 10 to 30 seconds in your vagina.

**9**

Withdraw the swab without touching the skin.

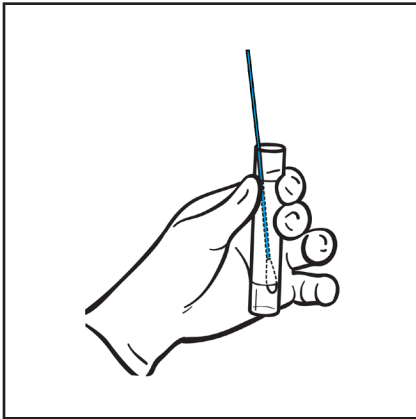

**Figure 5**

**10**

Place the swab into the test tube so that the tip of the swab is visible below the tube label as shown in **Figure 5**.

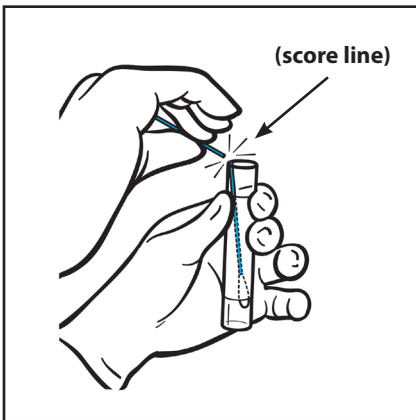

**Figure 6**

**11**

Break the swab shaft against the side of the tube as shown in **Figure 6**; use care to avoid splashing the contents of the tube. If tube is dropped, contents spilled, or if the swab flips out of the tube, please notify clinic staff.

**12**

Re-cap the tube tightly as shown in **Figure 7**.

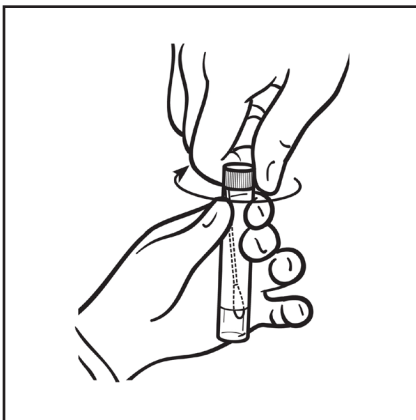

**Figure 7**

**NOTE:** If you have any questions about this procedure, please ask your clinic staff.